

# NEWS

**daisalux**

---

iluminación de emergencia • emergency lighting • éclairage de sécurité





Ziner

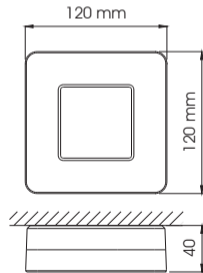
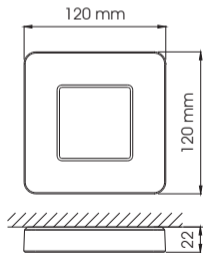

■ Ziner

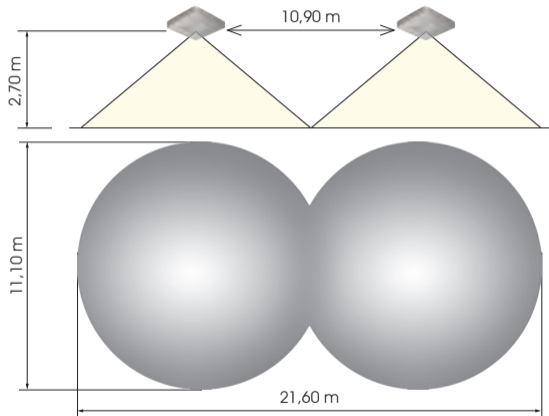

*1 lux / 1 h - Ziner N30 A/TCA*

# Ziner (EVC)

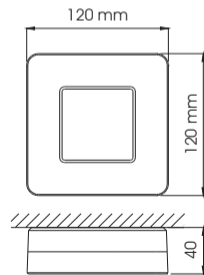
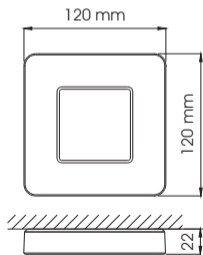

■ Ziner (EVC)

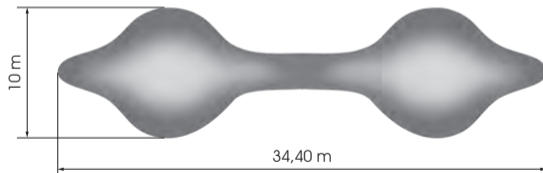
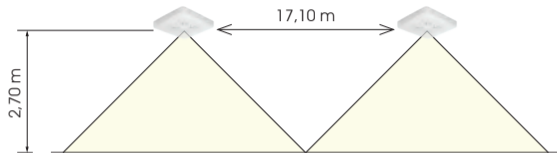

*1 lux / 1 h*  
*Ziner N30 A/TCA (EVC)*



Atria

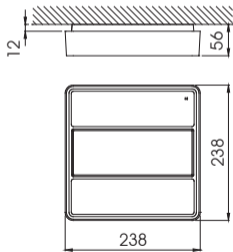

N22 (AT)



N48 (AT)



### ■ Atria (AT)

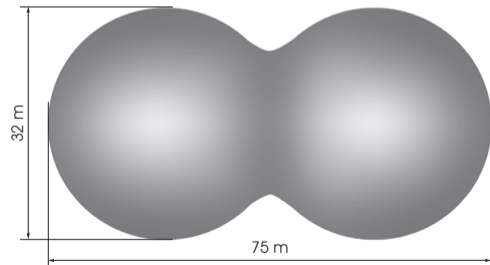
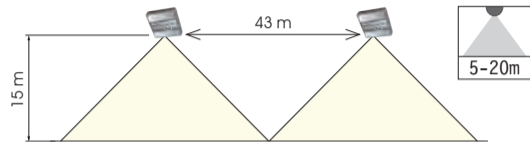

*1lux / 1 h - 2 Atria N48 A/TCA (AT)*

### ■ Atria (AP) + KP

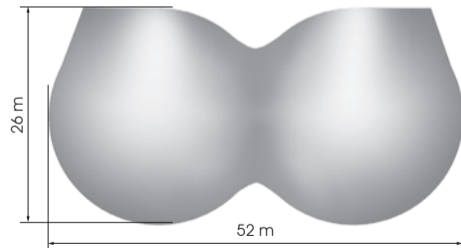
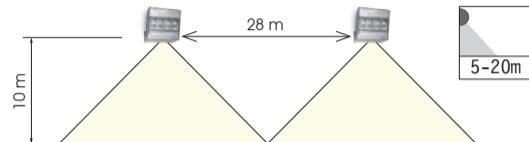

*1lux / 1 h - 2 Atria N48 A/TCA (AP)*



# Atria (EVC)

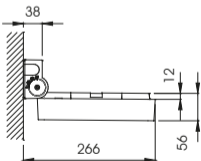
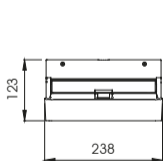
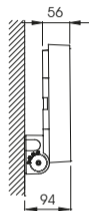
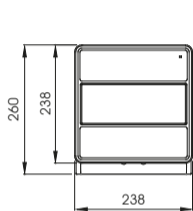

N22 (EVC)



N48 (EVC)



### ■ Atria (EVC)

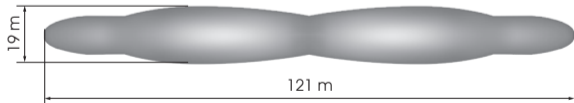
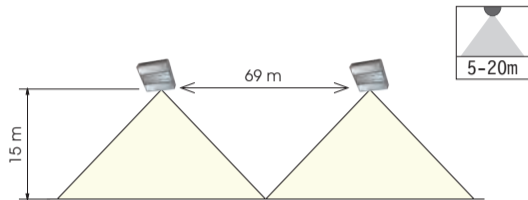

*1 lux / 1 h*  
*2 Atria N48 A/TCA (EVC)*

### ■ Atria (EVC) + KP

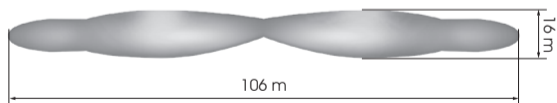
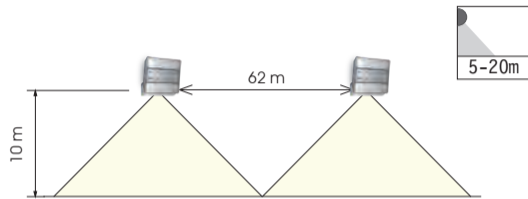

*1 lux / 1 h*  
*2 Atria N48 A/TCA (EVC)*



Block



+Info

\*BLA 

[www.daisalux.com](http://www.daisalux.com)



■ Block

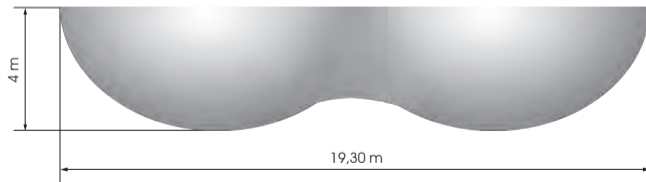
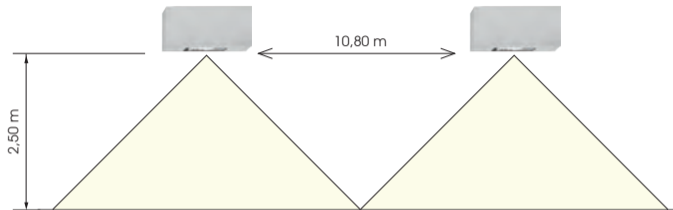

*Min. 1 lux*

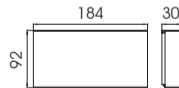

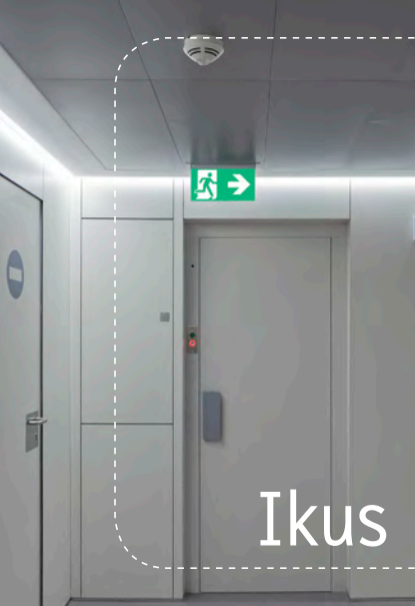

Ikus



320x160



220x110



220x220

+Info

\*IKB

[www.daisalux.com](http://www.daisalux.com)



IP  
65



■ **Ikus-M 320x160**

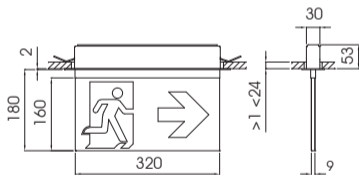

357 mm x 35 mm

■ **Ikus-P 220x110**

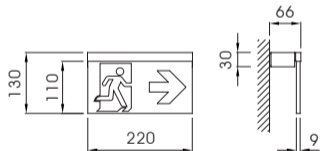

■ **Ikus-S 220x220**

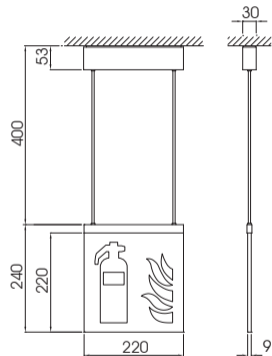



Izar

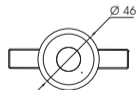
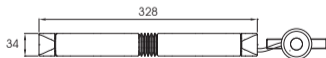
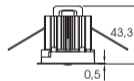
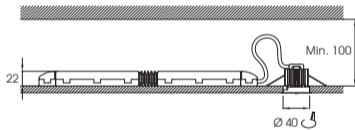

+Info  
\*IZAR | 🔍  
[www.daisalux.com](http://www.daisalux.com)



### ■ Izar

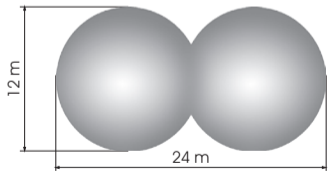
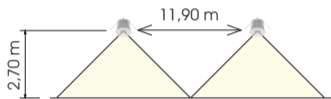

*Min 1 lux*

### ■ Izar (EVC)

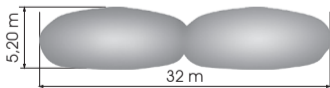
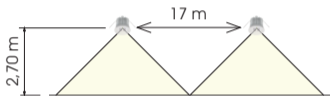

*Min 1 lux*

### ■ Izar (DIF)

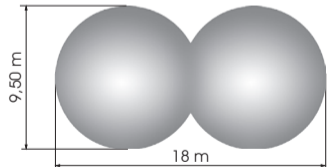
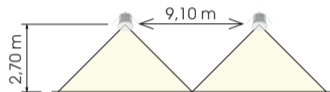

*Min 1 lux*





Lens



+Info  
\*XNA4 | 🔍  
[www.daisalux.com](http://www.daisalux.com)

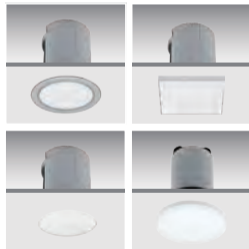

### ■ Lens (S)

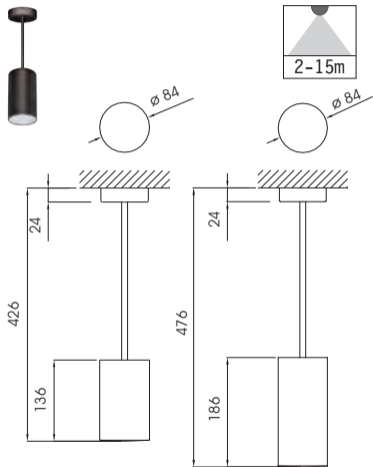

### ■ Lens (EST)

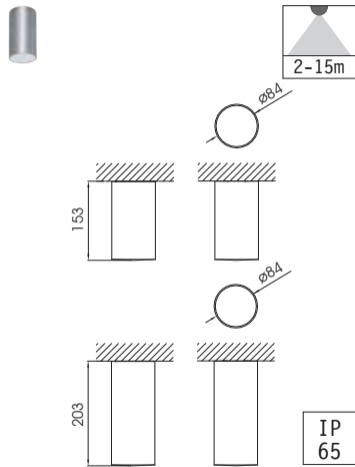

### ■ Lens (ESP, AEX)

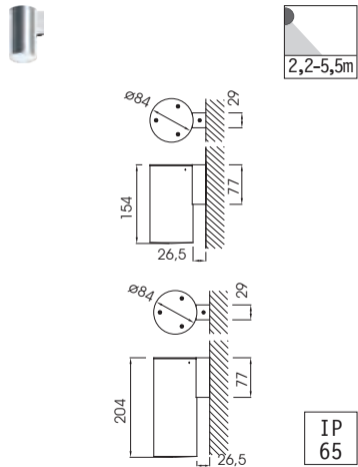

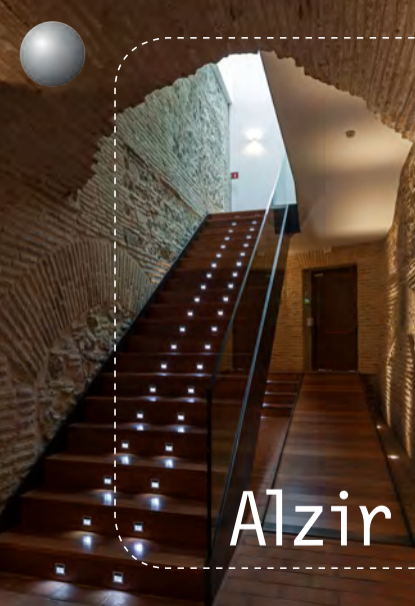

Alzir

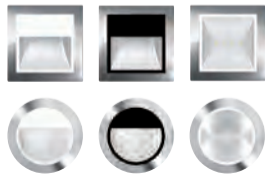

## ■ Alzir C

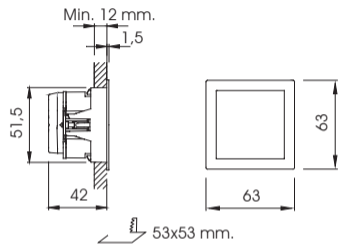

IP  
65

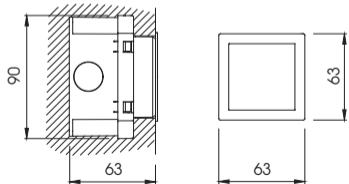

IP  
66

## ■ Alzir R

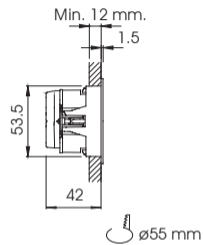

IP  
65

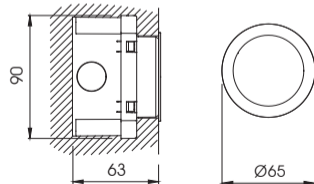

IP  
66

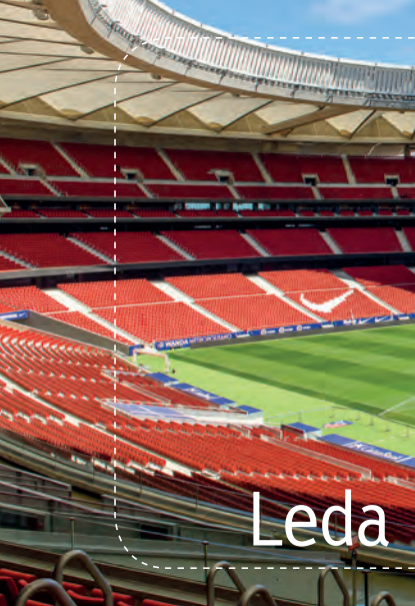

Leda



+Info  
\*LEB   
[www.daisalux.com](http://www.daisalux.com)

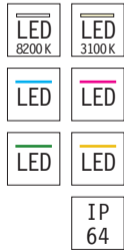

■ Leda

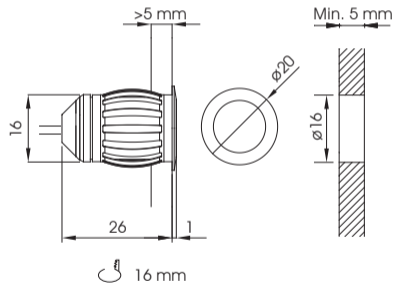

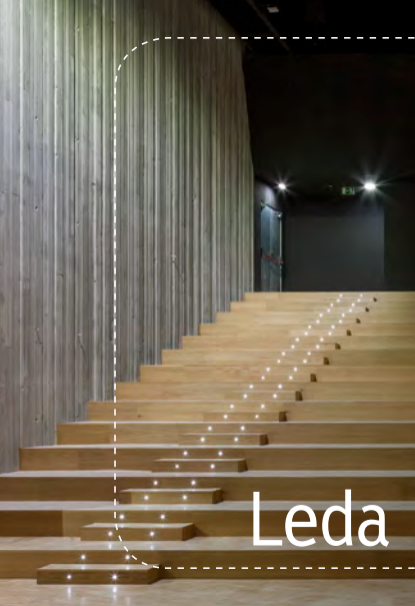

Leda

Leda-ES



Leda-MC



+Info  
\*LEB   
[www.daisalux.com](http://www.daisalux.com)



## ■ Leda-ES

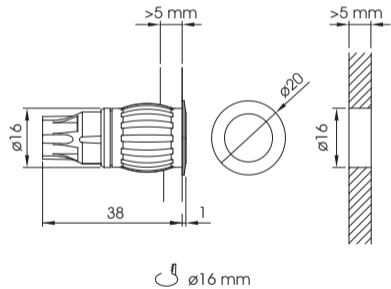

## ■ Leda-MC

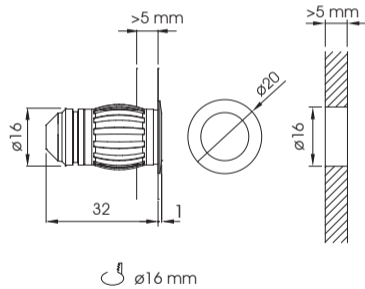





Clavo



Clavo-MD



Clavo



## ■ Clavo-MD

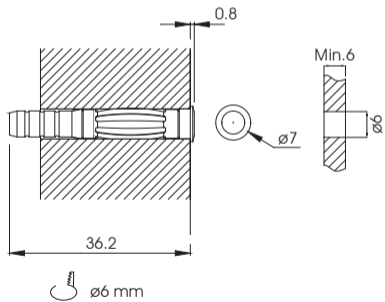

## ■ Clavo

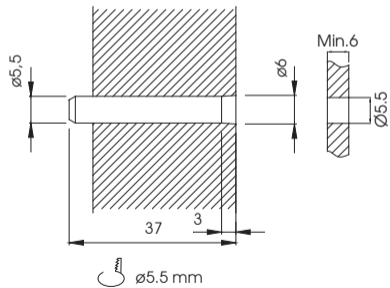



DaisaTest



+Info  
\*DTE | 🔍  
[www.daisalux.com](http://www.daisalux.com)





Ficha de luminaria

Ficha de luminaria

16429

Modificar

Ref. luminaria: LENS-40 N3 TCA

Características

Autonomía nominal (horas): 60  
Flujo nominal (lm): 146

Requisitos

Referencia	Cód. Fabric.
BAT-60-4C-LE	67245
LD-LE60-31TA	407 17 A

Estado actual de la luminaria:

Estado actual: En alerta, presencia de red

Indicador	Valor
Indicador de presencia	Presencia
Indicador de estado	27/04/2018
Autonomía (h)	100
Carga de batería (%)	100

Encendido y apagado

Encendido:

Apagado:

Modo:

Neutralización

Neutralización:

Últimos test funcionales

IP de serie	Fecha	Estado	On	Off
16429	12/04/2018	Ok		
16429	27/03/2018	Ok		
16429	11/03/2018	Ok		
16429	23/02/2018	Ok		
16429	07/02/2018	Ok		
16429	22/01/2018	Ok		

Últimos test de autonomía

IP de serie	Fecha	Autonomía (horas)	On	Off	Off
16429	25/04/2018	116			
16429	01/11/2017	1			
16429	24/09/2017	84			
16429	29/08/2017	89			
16429	24/06/2017	89			
16429	09/06/2017	31			



Daisa

+Info  
\*DSA   
[www.daisalux.com](http://www.daisalux.com)

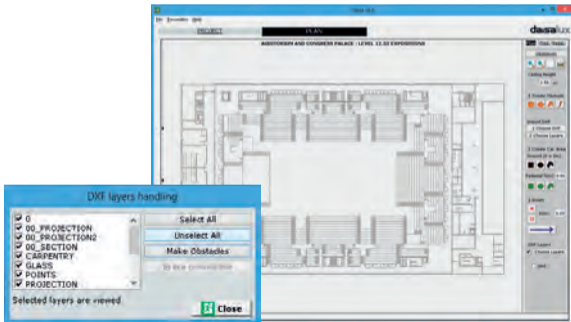

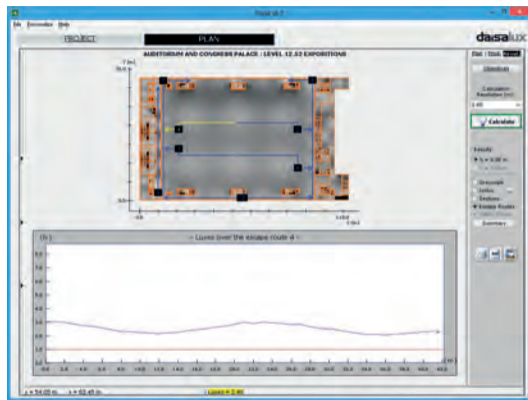
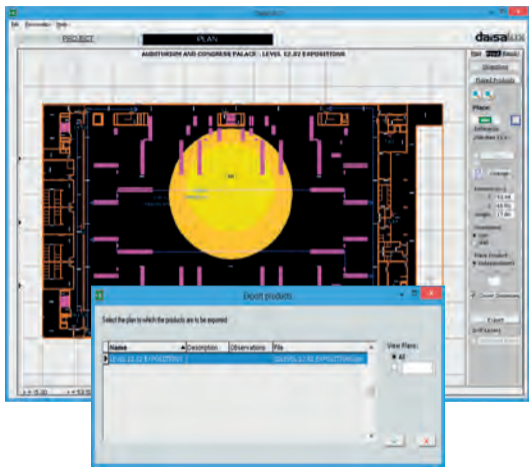



daxsalux





El **objetivo principal** en un proyecto de iluminación de emergencia es la **integración** de las luminarias necesarias en cualquier entorno arquitectónico. El catálogo más extenso del mercado, materiales de alta calidad y los nuevos desarrollos optoelectrónicos, nos permiten aprovechar al máximo la luz generada y hacerlo posible.

**Nuestro reto** comienza en el departamento de proyectos, que realiza miles de cálculos cada año. La filosofía común en todos los proyectos es **reducir** el número de luminarias instaladas asegurando el cumplimiento de las normativas vigentes y

manteniendo el protagonismo del entorno al que están destinadas.

Los diferentes objetivos luminotécnicos de cada país, han hecho que Daisalux mantenga una evolución constante del **Software de cálculo Daisa** para el correcto desarrollo de los proyectos, garantizando una **óptima** distribución de las luminarias para una correcta **evacuación**.

Para cálculos en grandes instalaciones, ofrecemos **luminarias con microprocesador interno**, capaces de comunicarse con un ordenador o control central. El **Sistema DaisaTest** realiza propuestas de mantenimiento

teniendo como objetivo **optimizar** los costes de mantenimiento y niveles de seguridad de la instalación de iluminación de emergencia.

La **experiencia adquirida** durante más de 30 años avalan nuestra filosofía de trabajo. Con un equipo joven y altamente cualificado, mantenemos un **diálogo** cercano con el arquitecto e ingeniero responsable de la iluminación. Ésto se ha traducido en la instalación de nuestras luminarias en numerosos proyectos a nivel mundial.



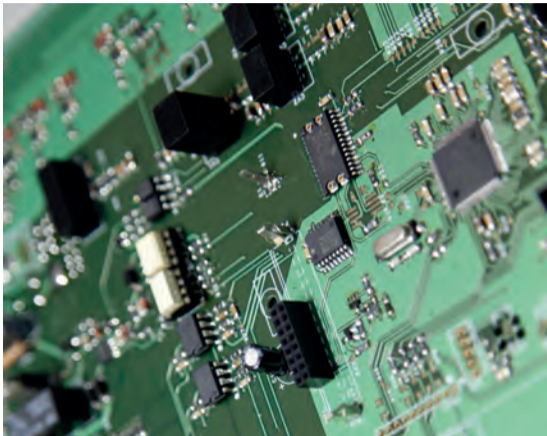

**The main goal** in an emergency lighting project is the **integration** of the luminaires necessary in any architectural environment. The market's most extensive catalogue, high-quality materials and new opto-electronic developments allow us to take full advantage of the light generated and to make it possible.

**Our challenge** starts in the projects department, which makes thousands of calculations every year. The common philosophy in all the projects is to **reduce** the number of luminaires installed, guaranteeing compliance with the regulations in force and

maintaining the protagonism of the environment to which they are destined.

The different lighting effect goals of each country have meant that Daisalux has constantly developed its **Daisa Calculation Software** for the correct development of projects, guaranteeing an **optimal** distribution of the luminaires for a correct **evacuation**.

For calculation in large installations, we offer **luminaires with an internal microprocessor**, capable of communicating with a computer or central control unit. The **DaisaTest**

**System** offers maintenance proposals with the aim of **optimising** maintenance costs and safety levels of the emergency lighting installation.

The **experience acquired** over more than 30 years back our work philosophy. With a young and highly qualified team, we maintain a close **dialogue** with the architect and engineer responsible for the lighting. This has translated into the installation of our luminaires in many projects around the world.



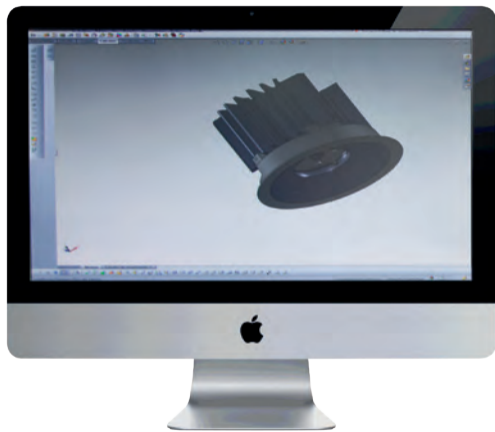
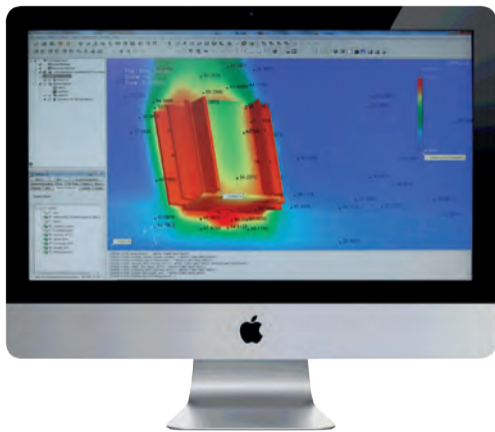

**L'objectif principal** d'un projet d'éclairage de sécurité est l'**intégration** des luminaires nécessaires dans tout environnement architectural. Le catalogue le plus riche du marché, des matériaux de haute qualité et de nouveaux développements optoélectroniques nous permettent de tirer le meilleur parti de la lumière générée et de concrétiser les projets.

**Notre défi** commence par notre département de projets, qui réalise des milliers de calculs chaque année. Notre philosophie commune à tous nos projets est de **réduire** le nombre de luminaires installés, tout en garantissant la conformité aux normes en vigueur

et en conservant le caractère de l'environnement où ils seront installés.

Les différents objectifs lumino-techniques de chaque pays ont mené Daisalux à maintenir une évolution constante du **Logiciel de Calcul Daisa** afin de proposer un développement correct des projets, et de garantir une distribution optimale des luminaires pour un **cheminement d'évacuation** correct.

Les calculs pour les grandes installations proposent des **luminaires à microprocesseur interne**, en mesure d'être connectés à un ordinateur ou à un contrôle centralisé. Le **Système DaisaTest** met en œuvre des

propositions de maintenance ayant pour objectif **optimiser** les coûts de maintenance et les **niveaux de sécurité** de l'installation d'éclairage de sécurité.

**L'expérience acquise** pendant pratiquement 30 années reflète notre philosophie professionnelle. Riches d'une équipe jeune et hautement qualifiée, nous travaillons dans un **dialogue** permanent et proche avec l'architecte ou l'ingénieur responsable des éclairages. Cela s'est traduit par l'installation de nos luminaires sur de nombreux projets dans le monde entier.



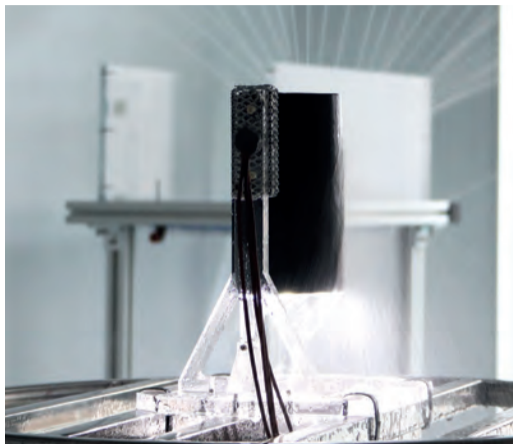





ER-0799/1998



GA-2010/0104



# daisalux

[www.daisalux.com](http://www.daisalux.com)  
[info@daisalux.com](mailto:info@daisalux.com)

